

Архангельск (8182)63-90-72
 Астана (7172)727-132
 Астрахань (8512)99-46-04
 Барнаул (3852)73-04-60
 Белгород (4722)40-23-64
 Брянск (4832)59-03-52
 Владивосток (423)249-28-31
 Волгоград (844)278-03-48
 Вологда (8172)26-41-59
 Воронеж (473)204-51-73
 Екатеринбург (343)384-55-89
 Иваново (4932)77-34-06

Ижевск (3412)26-03-58
 Иркутск (395)279-98-46
 Казань (843)206-01-48
 Калининград (4012)72-03-81
 Калуга (4842)92-23-67
 Кемерово (3842)65-04-62
 Киров (8332)68-02-04
 Краснодар (861)203-40-90
 Красноярск (391)204-63-61
 Курск (4712)77-13-04
 Липецк (4742)52-20-81
 Киргизия (996)312-96-26-47

Магнитогорск (3519)55-03-13
 Москва (495)268-04-70
 Мурманск (8152)59-64-93
 Набережные Челны (8552)20-53-41
 Нижний Новгород (831)429-08-12
 Новокузнецк (3843)20-46-81
 Новосибирск (383)227-86-73
 Омск (3812)21-46-40
 Орел (4862)44-53-42
 Оренбург (3532)37-68-04
 Пенза (8412)22-31-16
 Россия (495)268-04-70

Пермь (342)205-81-47
 Ростов-на-Дону (863)308-18-15
 Рязань (4912)46-61-64
 Самара (846)206-03-16
 Санкт-Петербург (812)309-46-40
 Саратов (845)249-38-78
 Севастополь (8692)22-31-93
 Симферополь (3652)67-13-56
 Смоленск (4812)29-41-54
 Сочи (862)225-72-31
 Ставрополь (8652)20-65-13
 Казахстан (772)734-952-31













Сургут (3462)77-98-35
 Тверь (4822)63-31-35
 Томск (3822)98-41-53
 Тула (4872)74-02-29
 Тюмень (3452)66-21-18
 Ульяновск (8422)24-23-59
 Уфа (347)229-48-12
 Хабаровск (4212)92-98-04
 Челябинск (351)202-03-61
 Череповец (8202)49-02-64
 Ярославль (4852)69-52-93

<https://yanmar.nt-rt.ru> || yama@nt-rt.ru





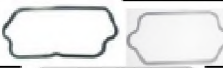



КАТАЛОГ



YANMAR

2TR7D (YM1100), 2TR13 (YM 1300), 2TR15 YM1500, 2TR17 (YM1700), 2TR20, (YM2000) 2TGR20 (YM2200), 2TR27 (YM2700)

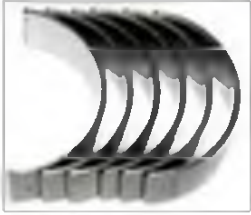
	Y-124901-22090	piston kit YM1110 2T72 72mm P20 C30mm
	Y-2T73-13	piston YM1100 73mm P23 C30mm (ex 2TR11)
	Y-623-100-20	« « « YM1300 75mm (2TR13) 124060-22090(2GM20F)
	Y-60-01-076	« « « YM1500 80mm (2TR15) P26 C32 124160-22090
	Y-60-02-015	« « « YM1700 85mm (2TR17) 124450-22090 P30C34
	Y-60-02-020	« « « YM2000 90mm (2TR20A) 124750-22090 P30C34
	Y-124763-22090G	« « « with rings 2TR20, 2T90 90mm p30c34
	Y-2TR13-11	rings/segments YM1300 75mm 2x2x2x4mm
	Y-2TR15-11	« « « YM1500 80mm 2.5x2.5x2.5x4mm
	Y-626-100-65	« « « YM1500 2TR15 80 (3x2.5 x4) 704300-22500(626-100-23)
	Y-2TR17-11	« « « YM1700 85 (3x2.5)x4 724450-22500(626-100-29)
	Y-626-100-24	« « « .2TR19 YM1900 88mm (3x2.5)x4
	Y-2TR20-11	« « « .2TR20 90mm (3x2.5)x4 724750-22500
	Y-626-100-31	« « « 90mm 2.5-2.5-2.5-4 (2T90) 724763-22500
	Y-626-100-30	« « « YM2200 2TGR20 90mm 2.5x2.5x2.5x4.5
	Y-60-02-206	liner/chemise YM1100 2T73 wet finish 724660-01900
	Y-60-02-205	« « « YM1300 (75) wet finish 724060-01900
	Y-60-02-207	« « « YM1500 (80mm) wet finish 721120-01900
	Y-724763-01900	« « « YM1600-1700 (85) wet finished 724450-01900 (60-02-209)
	Y-60-02-210	« « « YM2000-1900 green wet finished 90mm
	Y-60-2TR20A	head cylinder/culasse, 2TR20 YM2000 (295x190x90)724450-11701
	Y-60-01-313	head gasket/joint de culasse YM1110 2T72
		Y-2T73-2
		Y-2TR13-2
	Y-124060-01743	gasket oil pan/joint carter YM1300
	Y124060-11311G	Seal valve cover/Joint cache culbuteur 2TR13
		Y-2TR15-2
Y-124160-01743		gasket oil pan/joint carter YM1500
	Y-60-345-80	head gasket/joint de culasse YM1500 (80mm) TR (2TR15) 124160-01330
		Y-60-2TR15-3A
Y-124060-11310G		« « « « YM1500 OEM
	Y-121150-01330	head gasket/joint de culasse 3T80 (121150-01330) (ex TI-60-783-36) YM2500, YM2610
		Y-2TR17-2
Y-2TR17-2M		head gasket/joint de culasse YM1700 metal 124450-01132
	Y-124465-01752	gasket oil pan/joint carter YM1700-2000



Y-124950-11340G	valve stem seal 3T80U OEM Yanmar
-----------------	----------------------------------

















	Y-124763-01331	head gasket/joint de culasse YM195 YM2000/ YM240 Red 2TR20A 90mm (ex 124750-01331)(ex Y-60-01-325)
	Y-124772-01331	head gasket/joint de culasse YM1900/YM2000 Green 88mm piston 2TR20
	Y-124750-01331	« « « « YM2000 2TR20 90mm piston
	Y-60-06-101	gasket timing cover/joint de distribution YM1600- YM1900 124450-01510
	Y-124460-02150	seal cover/joint couvercle spy
	Y-60-2TR20-3A (ex 60-01-401)	gasket seal cover/joint couvercle spy. YM1700-2000
	Y-2T90-2	head gasket/joint de culasse YM2200 124550-01330 (ex Y-2TR22-2)
	Y-60-06-100	gasket timing cover/joint de distribution YM2200, YM2600, YM2700
	Y-3T84-20	con rod bearing/cousinet bielle STD 2TR13/3T84 124060-23300
	Y-3T84-21	« « « « 010 YM1300 (724064-23610) OEM
	Y-3T84-22	« « « « 020 YM1300/2220, 2301
	Y-124060-23300G	« « « « .STD YM1300/2301 OEM
	Y-724064-23610G	« « « « 010 YM1300/2301 OEM
	Y-124160-23600G	« « « « YM1500/YM2500 STD 50X21
	Y-124160-23380G	« « « « YM1500/YM2500 010 50x21
	Y-124450-23600G	« « « « YM1600-2000 STD (3T84) 55X25
	Y-124764-23380G	« « « « . 1600-2000 010 (3T84)
	Y-121550-02110G	main bearing/cousinet vilebrequin STD 2T73 2TR13 65x70x25.2 121550-02110
	Y-124064-02130	« « « YM 1100, 1300 010 65x70x25.2 124064-02130
	Y-124160-02101	« « « .YM1500 STD OEM 71x75x33.5 124160-02101
	Y-124160-02130	« « « YM1500 010 71x75x31 OEM 124160-02130
	Y-121150-02370	« « « main front 0.25 YM2500
	Y-121150-02380	« « « main 2nd 0.25
	Y-121250-02101G	« « « STD 2TR16-20 71x75x33.2 OEM 121250-02101
Y-124764-02130G	« « « 1600/2000 010 70X33.2 124764-02130	
Y-2TR20-27	« « « YM1600/1700/2000 020 70X33.2	
	Y-104200-11100G	valve in /soupaped'aspiration 2TR13 OEM 7x32x97.30
	Y-104200-11110G	valve ex/ soupaped;echapement 2TR13 OEM 7x27x97.30
	Y-101218-11100G	valve in /soupaped'aspiration 2TR15 OEM 7x33.5x106.5
	Y-101218-11110G	valve ex/ soupape echapement 2TR15 OEM 7x27.5x106.
	Y-104600-11100G	valve in /soupape aspiration 2TR20 OEM 8x38.5x114.4
	Y-104600-11110G	valve ex/ soupape echapement 2TR20 OEM 8x32.4x114.4
	Y-124460-11340G	valve seal/joint soup. 2TR16-20 3T84-1A



	Y-104600-11100G	valve in/soupape aspiration 2TR17
	Y-104600-11110G	valve ex/soupape echap 2TR17
	Y-124060-02110G	thrust bearing/calage 2TR13 <small>124060-02110</small>
		thrust bearing/calage 2TR15 <small>124450-02110</small>
	Y-60-06-389	seal crank front /joint vbq frontal YM1300-YM2210, Ym2610, YM2820-3220, 58-80-12 AE3154E 124450-01800 HTCR
	K-09560-00004	rear crankshaft seal/joint vbq post YM1300 65-88-9 (AH3508P) TC
	Y-124450-21230G	bushclutchshaft/baguearbre 1er YM1100-YM3000
	Y-124060-32011	oil pump/pompe a huile 2TR13
	Y-724450-32700	oil pump/pompe a huile 2TR15
	Y-124455-32000	oil pump/pompe a huile 2TR20









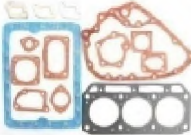

3T70(YM1301) 3T72 (YM1401, YM1501, F15) 3T75 (YM1601, F16, YM1701, YM1720), 2T80(YMG2000), 3T80(YM2500), 3T82 (YM2010), 3T84 (YM2310, YM2620), 2T90 (YM2210)

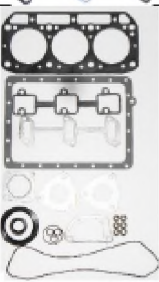
	Y-60-02-010	piston YM1401 YM1501 F15 (3T72) 721450-22721, 121450-22091 P20 C27.6mm
	Y-3T72-13	« « « « 72mm TW P21
	Y-121450-22091G	piston kit 72mm YM1401 F15 P20 C26 OEM
	Y-60-02-012	« « « « YM1601-1702, F16 3T75 <small>721575-22500</small>
		P20C27.5
	Y-105311-22090G	piston kit 3T75-U YM1601 F16
	Y-60-01-134	« « « « YM 1802 (3T80) P23C28 721520-22500
	Y-3T84-13A	« « « « 84mm TW+/rings129367-22030 P26 C30
	Y-3T84-13	« « « « 84mmTW <small>129350-22090/129367-22090 P26 C30</small>
Y-3T84-1A-13	« « « « 84mm YM3000 3T84-1A P30C34mm	
Y-121252-22090G	« « « « 84mm YM3000 3T84-1A P30C34mm OEM with rings	
	Y-3TN100-13	« « « « « 100mm 3TN100
	Y-3T70-11	rings/segments 3T70 2x2x4 YM1301
	Y-3T72-11	« « « « 3T72 72mm 2x2x4 721450-22500
	Y-3T72-11T	« « « « 3T72 TR 72mm 2x2x4
	Y-626-100-66	« « « « 3T72 YM1401 F15 2x2x4mm
	Y-626-100-68	« « « « 3T75 YM1601 F16 2x2x4mm
	Y-3T75-11	« « « « 3T75 2x2x4mm 721575-22500
	Y-3T75-11T	« « « « 3T75 2x2x4mm 721575-22500
	Y-626-100-71	« « « 80mm YM2000 2x2x4 (3T80U-NB <small>721520-22500</small>
	Y-3T80-11	« « « 80mm YM1800, TR(3T80) (2x2x4)
	Y-626-100-26	« « « 82 YM2010 2x2x4(626-100-69847)729351-22500
	Y-626-100-28	« « « 84mm YM3000 (3T84) 3x2,5-4 721252-22500
	Y-3TN100-11	« « « 3TN100
	Y-2T72-15	liner/chemise 72mm (finished) TW
	Y-3T72-15	« « « 72mm
	Y-60-02-217	« « « F14 72mm 121450-01100
	Y-60-02-218	« « « F16, F17, YM1601, YM1610 75mm
	Y-60-02-219	« « « F15, F145, YM1401, YM1501 75mm
	Y-60-02-134	« « « YM1802 80mm
	Y-3T84-16A	« « « 84mm 3T84, 3D84 88 ext. VN
	Y-3T84-16F	« « « 84mm 3T84 (finished) TW
	Y-3T84-16	« « « 84mm 3T84 TW 129350-01100
		Y-729350-11700

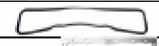

	Y-129350-11410	Dispenser Diesel 3T84 D=32mm
	Y-60-3T84	cylinder head/culasse 3T84-1-A YM3000 (410x190x90) (YM2500, YM2601)

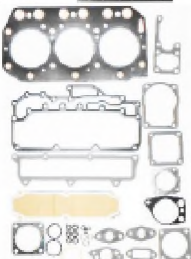
	Y-2T72-2	head gasket/joint de culasse 2T72 (2GM20F)
	Y-2T72-4	set gasket full/pochette joints complet
	Y-2T75-2	head gasket/joint de culasse 2T75 (YM14)
	Y-3T70-2	* * * * YM1301 (3T70B) (ex TI-60-335-70)
	Y-3T70-2A	* * * * F13 3T70
	Y-3T72-2	* * * * YM1401 (3T72) TW HGY2002
	Y-3T72-3	set upper gaskets/pochette joints sup 3T72 HHY2002
	Y-3T72-4	set gasket full /pochette joints complet 3T72 77105-11991
	Y-121450-11310G	seal valve cover/joint cache culbuteur YM1301, YM1510
	Y-3T72SB-2	head gasket/joint de culasse YM1401
	Y-3T72SA-2	* * * * YM1510
	Y-3T75H-2	* * * * YM1810 121550-01330 (305x150mm)
	Y-121470-01330	* * * * YM1601 F16 (3T75) (ex TI-60-01-301)
	Y-121470-01332G	* * * * YM1601 F16 (3T75) OEM Yanmar
	Y-129350-11310G	seal valve cover/joint cache culbuteur YM1601 F16
	Y-121450-12710G	seal air/joint aspiration OEM
	Y-60-06-504	* * * * YM1301-1401-1610 (ex 60-06-505)
	Y-121450-13251	gasket exh./joint echapement 3T75
	Y121450-01511	gasket gear cover/joint couvercle distributeur 2T72, 3T72, 3T75
	Y-121450-01751	oil pan gasket/joint carter 3T72, 3T75
	Y-124160-11340G	valve seal /joint de soupape 2TR15, 3T75 2T73, 3T80 7x12x9
	Y-2T80-2	* * * * 2T80
	Y-121567-01330	* * * * YM1802 ,1820 3T80U-NB
	Y-3T80B-2	* * * * YM1802 YM1820. 3T80U-NB (ex TI-60-01-323) 121567-01330

	Y-3T80B-4	gaskets set full/ pochette complete 3T80 YM1802 w/o had gasket.oil seals
	Y-121550-11310	seal valve cover/joint cache culbuteur YM1810 YMG2000
	Y-121551-12710G	seal air/joint aspiration YM1802
	Y-121575-01751	oil pan gasket/joint carter YM1820

	Y-3T82B-2	head gasket/joint de culasse 3T82 (TI-60-347-82) 129351-01330
	Y-3T82B-4	full set gaskets/ pochette complete 3T82 YM2002 without head gasket and crank seals
	Y-129322-13521	gasket exh./joint echapement YM2001
	Y-3T84-2	* * * * 3T84 (129332-01330)
	Y-3T84-3	set upper gaskets/pochette joints sup 3T84 HHY2006G
	Y-3T84-4	full set gaskets/pochette joints complete 3T84
	Y129350-12710G	seal air/joint aspiration YM2010
	Y-60-06-503	* * * * YM2001
	Y-3T84-1A-2	head gasket/joint de culasse YM3000, YM330 121250-01331
	Y-121250-11350G	seal valve cover/joint cache culbuteur YM3000
	Y-121250-12710	seal air/joint aspiration YM3000
	Y-121250-13521	gasket exhaust/joint echap. YM3000
	Y-121250-01752	gasket oil pan/joint carter YM3000
	Y-3TN100-2	head gasket/joint de culasse 3TN100 729380-92605
	Y-3TN100-3	set upper /pochette joints sup 3TN100
	Y-3TN100-4	gaskets full set /pochette joints complete 3TN100 (w/o crank seals)
	Y-60-06-105	gasket timing cover/joint distribution YM1610 121450-01512
	Y-60-06-104	* * * YM1301-1401 (3T70, 3T72)
	Y-60-06-103	* * * YM2001-2010-2310, Ym2420
	Y-60-06-005	oil pan/joint carter YM13-1401 3T70/T72)
	Y-60-06-004	* * * YM2310 (3T84H-S), YM2001, (3T82B)

	Y-3T72-17	valve in/soupape aspir 3T72 7x29,6x87,2 used
	Y-3T72-18	valve ex/soupape ech.3T72 7x25x87,2 used
	Y-105225-11100G	valve in/soupape aspiration 3T75 7X32X90.6
	Y-105225-11110G	valve ex/soupape echap 3T75 7X26X90.6
	Y-104211-11100G	valve in/soupape aspir.YMG2000 7x32x95.5
	Y-104211-11110G	valve ex/soupape echapYMG2000 7x27x95.5
	Y-129350-11100G	valve in/soupape aspir. YM2310 8X35x100
	Y-129350-11110G	valve ex/soupape echapYM2310 8x29x100

	Y-121422-11100G	valve in/soupape d'aspiration YM3000 8x38x114
	Y-121422-11110G	valve ex/soupapeechap YM3000 8x32.5x114
	Y-104800-11100G	valve in/soupape aspiration 3T84-1A 8x38x115
	Y-104800-11110G	valve ex/soupapeechap 3T84-1A 8x32.5x115
	Y-121450-01800	crank seal front/joint vbgfrontal YM1301/1401/1501/1601/1702 25-40-8 AH1314AP <small>(ex TI-60-06-184)</small>
	Y-124450-02220G Y-124450-02220	seal crank rear/joint vbg post HTCL YM1301/1702 60-82-9 AH3220F (ex TI-60-04-463)
	Y-3T84-8	« « « « « « 65-88x9 AH3399F 2T75, 3T84
	Y-124950-21230G	bush clutch shaft/bague arbre 1 F14. YM1601

	Y-705311-23600G	con rod bearing/cousinetbielle STD 3T75 40x43x17 ^{705311-23600 (3GM30F)}
	Y-105311-23380G	« « « « « 010 3T75/T72 40x43x17 105311-23380
	Y-3T75-20	« « « « « STD 3T75 R3T72K-STD
	Y-3T75-21	« « « « « 010 3T75
	Y-3T75-22	« « « « « 020 3T75
	Y-3T80U-NB-20	« « « « « STD 3T80U 44x19 ⁷²¹⁵⁵⁰⁻²³⁶⁰⁰ 2T75AT
	Y-3T80U-NB-21	« « « « « 010 3T80U44x19 121550-233080
	Y-3T80U-NB-22	« « « « « 020 3T80U 44x19 121550-233080
	Y-721550-23600G	« « « « « STD 3T80U 44x19 ⁷²¹⁵⁵⁰⁻²³⁶⁰⁰ OEM
	Y-121550-23380G	« « « « « 010 3T80U 44x19 121550-23380 OEM
	Y-3T84-20	« « « « « STD 3T84 47x18.5 TC850 (2TR13)
	Y-3T84-21	« « « « « 0103T84 47x18.5 TC850 (2TR13)
	Y-3T84-22	« « « « « 020 3T84 47x18.5 TC850 (2TR13)
	Y-124450-23600G	« « « « « STD 3T84 1A YM3000 OEM 54x25.5 ¹²⁴⁴⁵⁰⁻²³⁶⁰⁰
Y-124450-23350G	« « « « « 010 3T84 1A M3000 OEM 54x25.5 ¹²⁴⁴⁵⁰⁻²³³⁵⁰	
Y-3TN100-20	« « « « « STD3TN100	
Y-3TN100-21	« « « « « 0.253TN100	
	*Y-3T75-25*	main bearing set/jeu des coussinets vilebrequin 3T75 STD 1 st (44x49 ring) 2 nd (45.5x49x17) 3 rd (44x23) 4 th (60x20.2 ring) (3GM30F)
	Y-3T75-26	« « « « « 010 3T75 (3T72)
	Y-3T80U-NB-25	« « « « « 3T80U-NB std YM2002 OEMfront 45x52x24.5 121520-02100/ 2nd 47x22 7 21550-02810/ 3rd +thrust 48x30 OEM 721550-02800/year 85x70x25.5 OEM 121550-02110
	Y-3T80U-NB-26	« « « « « 3T80U-NB YM2002 010 OEM
	Y-3T84-25	« « « « « STD3T84 ^(129350 02100/729350 02810/729350-02800/121550 02110) M52623
	Y-607-100-10	Main 1 st /cousinetvbg60x66x22.5 3T84 (129350-02100)
	Y-3T84-26	main bearing set/jeu des coussinets vilebrequin 3T84 010 M52623
	Y-3T84-27	3T84 020 M52623
	Y-3T84-1A-25	STD YM3000 OEM
	Y-3T84-1A-26	010 YM3000 OEM
	Y-3TN100-25	STD
	Y-3TN100-26	0.25
	Y-123900-02410G	camshaft bush 4TNE106
	Y-129350-32090	oil pump 3T75
	Y-721390-32100	« « « « YM330 YM3000 3T80, 3T90 (721252-32100)

1 cylinder engines/ moteursMonocylindres

K-TS60-2	head gasket/ joint culasse 70mm piston
----------	--

	Y-YM72-2	« « « « « « « « « « 72mm piston
	Y-TS80-13	piston 80mm flat P26C31.5 grooves 2.5x2.5x2.5x4
	Y-TS105-13	« « « « 85mm flat P26C32 grooves 2.5x2.5x2.5x4
	Y-TF115-13	« « « « 92mm flat P26C40 grooves 2.5x2.5x2.5x4
	Y-TS80-11	rings/segments 80mm 2.5x2.5x2.5x4
	Y-TS105-11	« « « « 85mm 2.5x2.5x2.5x4.00
	Y-TF115-11	« « « « 92mm 2.5x2.5x2.5x4.00
	Y-TS155-11	« « « « 95mm 2.5x2.5x2.5x4.5
	Y-TF160-111	« « « « 102mm 2.5x2.5x2.5x4.5
	Y-TS70AT-20	con rod bearing/cousinetbielle STD TS70, TS8044x26 103288-23300
	Y-TS70AT-21	« « « « 010 44x26
	Y-SA80AT-20	« « « « STD 50x20
	Y-SA80AT-21	« « « « 010 50x20
Y-TS105AT-20	« « « « STD 46x28	
Y-TS105AT-21	« « « « 010 46x28	
Y-TF115AT-20	« « « « STD 48x26	
Y-TF115AT-21	« « « « 010 48x26	
Y-TF115AT-22	« « « « 020 48x26	
Y-TS155AT-20	« « « « STD 53x31	
Y-TS155AT-21	« « « « 010 53x31	
Y-TF160AT-20	« « « « STD 53x33	
Y-TF160AT-21	« « « « 010 53x33	

3TNA68 (KE-3),3TNE68 (ke-30) 3TNA72, 4TN78(4JHmarine)(F-FX26, F,FX28) 3TN82 (F20, FX20,F24, FX24)) 3TN84(F22, FX22) 3TNV88, 4TNV106 (komatsuS4D106)

	Y-3TNE66-13K	piston STD 3TNE66 TK366A P20 C18.1119200-99100
	Y-3TNE66-13	« « STD 66mm 3TNE66 P20C23 119270-22010
	Y-3TNV66-13	« « STD 3TNV66 P20C28
	Y-3TNE68-13	« « STD 68mm 3TNE68 TW (Flower) P20C18
	Y-3TNA68-13	« « STD 68mm 3TNA68 TW (Flower) P21C27
	Y-3TNA72-13	« « STD 72mm TW (Flower) P=21 C=27.5 TK388
	Y-3TNA72-14	« « 72.5 mm TW (Flower) P=21 C=27.5
	Y-3TNE72K-13	« « STD 72mm TW (Flower) P=21 C=23 TK395
	Y-3TNE74-13	« « STD 74mm TW 119623-22080 P21C23
	Y-3TNV70-13	piston STD 3TNV70
	Y-3TNV76-13	« « STD 3TNV76 P23C33
	Y-4D94LE-13	« « STD 94mm P30C40.5 129931-22100
	Y-4TNE94-13A	« « STD 4D94E P30 C45.4 129901-22080
	Y-4TNE94-13E	« « STD 94mm P30C44.8mm (4D94E) 129901-22080
Y-4TNE98-13	« « STD 98mm 4D98E 129903-22081 Comp. 56mm	
Y-129555-22090	piston STD FX42 78mm	
Y-3TNB80-13	« « FX18 80mm pin 26 compr 37mm	
Y-3TNB82-13	« « FX20 82mm FLAT	
Y-129157-22090G	« « FX24 84mm (KIT with rings) P26C36 3TNB84	
Y-3TN75L-13	« « STD 75mm P23C33 conc 41mm 119810-22080	
Y-4TNA78-13	« « STD FX28 78mm TW + rings	
Y-3TNA78-13	« « STDFX28 78mm TW C27.3 Conc 37	
Y-4TNA78-14	« « 78.50mm FX28 P26,C37.5 conc 42	
Y-3TNE78-13	« « STD 3TNE78, 3TNB78 P23C27.5 conc 41 +rings	
Y-3TNC78-13A	« « STD 3TNC78 rings/segments C30 Conc 50	
Y-3TNB78-13	« « STD 3TNB78 P23C39	
Y-3TNC80-13	« « STD 3TNC80 80mm P23 C29.5 Compr.43.50	
Y-3TN82-13	« « STD 3TN82 82mm P26 C37.5 conc 44	



	Y-3TNE82-13	« « STD 3TNE82 82mm CD1005 27.5 119813-22080
	Y-3TNE82A-13	« « STD 3TNE82 82mm P26 C27.5 Con 44 EF series
	Y-3TNE82A-14	« « 82,5mm compr 27.5 119813-22080
	Y-3TN84-13	« « STD 3TNA84 P26C37 con 45.5m 129002-22081
	Y-3TN84-14	« « 84.5mm 3TNA84 (3TN84L) P26C37 TW
	Y-3TNB84-13A	« « STD 84mm +rings P26 C36.2 con 47mm
	Y-3TNE84-13	« « STD 84mm 3TNE84 P26C34 C45mm 129002-22090
	Y-3TNE84-14	« « 84.5 mm 3TNE84 34mm oversize
	Y-4TNV84-13	« « STD 84mm 4TNV84 P26C34.2con41.3 129508-22080
	Y-4TNE86-13	« « STD 86mm 4TNV86 P26C34.5C46.8 729486-22090
	Y-3TNV84-13	« « STD 84mm 3TNV84 TW
	Y-4TNV88-13	piston STD 88P26C34.5conc 43mm 129005-22080 3JH5E
	Y-3TNC88-13	« « STD 88mm P26C34.5conc 48mm 129001-22080
	Y-4TNE94-13	« « STD 94mm 4TNE94 + rings/segments
	Y-4TNE94-DI-13	« « STD P30mm C45mm con50mm 129800-22080 4D94E
	Y-4TNV94-13	« « STD 944TNV94L P30C40conc 129906-22080
	Y-4D94-13	« « STD 94mm Conc+1valv P32C39.50 conc 50mm 129901-22080 KOMATSU
	Y-4TNV98T-13	pistonSTD 98mm P30C40 conc 50mm 129908-22080
	Y-4D98E-13	« « STD 98KOMATSU 129002-22080 P30 C40 conc 53
	Y-4TNE106T-13	« « STD 106mm CON.+2VAL P37C43 conc 60 123901-22011 Micky mouse
	Y-4TNE106-13	« « STD 106mm 123900-22080 P37 C43 conc 60Micky mouse
	Y-4TNE106-14	« « 106.50 P37C43 conc 60mm 123900-22080- 050Micky mouse
	Y-4TNV106-13	« « STD 106mm P37C43conc 55 K123907-22011
	Y-3TNE100-13	« « STD 3TNE100

	Y-3TNE66-16	liner/chemise 66mm x120 mm 3TN66
	Y-3TNA68-16	« « 68x71.5xmm x140x142 mm 3TN68
	Y-3TN72-16	« « 72mmx75.5 x140x135 mm 3TN72
	Y-3TN78-15	« « 78mm x140 mm 3/4TN78 (finished)
	Y-3TN78-16	« « 78mm x140 mm 3TN78/4TN78 (FX-26)
	Y-3TN82-15	« « 82mm x140 (finished)
	Y-3TN82-16	« « 82mm x140
	Y-3TNA84-16	« « 84mm x140 mm 3TNA84 FX-24
	Y-3TNC88-16	« « 88mm x155
	Y-4TNE94-16	« « 94mm
	Y-4TNE98-16	« « 98 mm
	Y-4TNV106-16	« « 106mm
	Y-3TNV66-11K	rings/segments 66mm 1.5Kx1.5x3 3TNA66 119209-22500
	Y-3TNA66-11	« « 66mm 1.5kx1.5x3,5 3TNA66 719270-22501TK366
Y-626-100-67	« « 68mm KE3 3TNA68 1.5-1.5-3.5	
Y-3TNE68-11	« « 68mm 1.5x1.5x3 3TNE68 119265-22500	
Y-3TNA68-11	« « 68mm 1.5x1.5x3.5 3TNA68	
Y-3TNV70-11T	« « 70mm 1.5x1.5x3 3TNV70 TR	
Y-3TNV70-11	« « 70mm 1.5HKx1.5x3 3TNV70 RIK	
Y-3TNA72E-11	« « 72mm 1.5x1.5x3.5 3TNA72 119620-22500	
Y-3TNA72E-12	« « 72.5mm 1.5-1.5-3.5 3TNA72E 119620-22500	
Y-3TNE72K-11	« « 72mm1.5K-1.5-3 3TNE7271962-22500	
Y-3T72-12	« « 72.5mm2-1.5-4	
Y-3TNE74-11	« « 74mm 1.5Kx1.5x3 3TNE74	
Y-3TNA74-11	« « 74mm 1.5x1.5x3 3TNA74 119623-22500	
Y-3TNA74-12	« « 74.5mm 1.5x1.5x3 3TNA74	





	Y-3TNV76-11	« « 76mm 1.5x1.5x3 3TNV76
	Y-4TN78-11	« « 78mm 2x2x4 FX28 4TN78) 129590-22510
	Y-4TN78-12	« « 78.502x2x4 FX26 4TN78
	Y-3TNC80-11	« « 80mm 2x2x3/4 3TNC80 721520-22500
	Y-626-100-69	« « 82mm 2x2x4 F20 3TNB82 626-100-47/26
	Y-3TNE82-11	« « 82mm 2.5Kx2x5 3TNE82 129537-22500
	Y-3TNE82-12	« « 82.50 mm 2x2x4 3TNE82
	Y-3TNA84-11	« « 84mm 2x2x4 3TNA84 129002-22500
	Y-3TNA84-12	« « 84.502x2x4 3TNA84 129002-22500
	Y-4TNE86-11	« « 86mm 2x2x4 4TNE86 729486-22090
	Y-4TNC88-11	« « 88mm 2Rx2x4 4TNE88 129001-22500
	Y-4TNV88-11	« « 88mm 2x2x4 4TNV88 129001-22500NPR
	Y-626-100-55	« « 88mm 2x2x4 4TNV88 TH
	Y-4TNE94-11	« « 94mm 2Kx2x3 4TNE94 127610-33612
	Y-4TNE98-11	« « 98mm 2Kx2x3 4TNE98129903-22050/129002-22080
	Y-3TNE100-11	« « 100mm 2x1.5x3 3TNE100
	Y-4TNV106-11	« « 106mm 2,5Kx2x3 4TNE/V106mm DK040290Z
	Y-4TNV106-12	« « 106.50mm 2,5Kx2x3 4TNE/V106



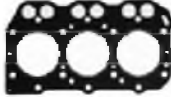
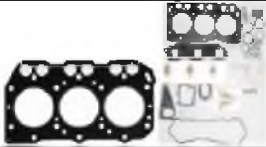

Cylinder heads/Culasses Yanmar



	Y-3TNV70-45	cylinder head/culasse 3TNV70
	Y-729156-11700	cylinder head/culasse 3TNB84 FX20, FX22, FX24
	Y-4TNE84-45	cylinder head/culasse 4TNE84
	Y-4TNV84-45	cylinder head/culasse 4TNV84
	Y-4TNE94-45A Y-4TNE94-45B	cylinder head/culasse 4TNE94 Type 1 and Type 2
	Y-4TNV98-45	cylinder head/culasse 4TNV98





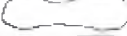

	Y-2TN66-2 Y-2TN66-4	head gasket/joint de culasse 2TN66/68 (TK249) OEM gasket set full/pochette joints 2TN66
	Y-3TN66-2	head gasket/joint de culasse 3TN66 HGY2004
	Y-3TN66-2MT Y-3TN66-3 Y-3TN66-4	head gasket/joint de culasse 3TN66/3TN68 metal OEM 119265-01341 TK366 set gaskets upper/pochette joints sup 3TN66 gasket set full/pochette joints 3TN66 HFY-2004

	Y-3TNA68-2	head gasket/joint de culasse 3TNA68 (119656-01340)
	Y-3TNA68-3	set gaskets upper/pochette joints sup 3TNA68 HHY2004D
	Y-3TNA68-4	gasket set full/pochette joints 3TNA68 719643-92602
	Y-3TNE68-2MT	head gasket/joint de culasse 3TNE68 metal 119265-01341 TK374
	Y-3TNE68-3MT	set gaskets upper/pochette joints sup 3TNE68
	Y-3TNE68-4MT	gasket set full/pochette joints 3TNE68

	Y-3TNV70-2	head gasket 3TNV70
	Y-3TNV70-4	full set gaskets 3TNV70
	Y-3TN72-2	head gasket/joint de culasse F15 (3TN72) TW HGY2003
	Y-3TN72-3	set gaskets upper/pochette joints sup 3TN72 TW HHY2003
	Y-3TN72-4	gasket set full/pochette joints 3TN72 TW
	Y-3TN72-2MT	head gasket/joint de culasse 3TNE72 TW metal HGY2005A
	Y-3TN72-2MTG	« « « 3TNE72/3TN74 OEM metal
	Y-3TN72-3MT	set gaskets upper/pochette joints sup 3TNE72 TW metal HHY2005A
	Y-3TN72-4MT	gasket set full/pochette joints 3TNE72 TW metal
	Y-3TN74-2	head gasket/joint de culasse 3TN74 (TK398) 119623-01330
	Y-119623-01340G	Head gasket OEM 3TNE72-3TNE74
	Y-3TN74-3	set gaskets upper/pochette joints sup 3TN74 metal HHY2005B
	Y-3TN74-4	gasket set full/pochette joints 3TN74 metal (719623-92650)
		Y-3TN75-2
	Y-3TN75-4	gasket set full/pochette joints 3TN75 F16
	Y-3TNV75-2	head gasket/joint de culasse 3TNV75 (75mm piston)
	Y-3TN78-2	head gasket/joint de culasse F18 (3TN78) TW HGY2005K
	Y-3TN78-2A	head gasket/joint de culasse 3TN78 extra water holes
	Y-3TNE78-3	set gaskets upper/pochette joints sup 3TNE78 HHY2005L 119818-01330
	Y-3TNE78-2MT	head gasket/joint de culasse 3TNE78 HGY2005L
	Y-3TNE78-3MT	set gaskets upper/pochette joints sup 3TNE78 metal HHY2005L

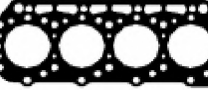
	Y-3TNE78-4	gasket set full/pochette joints 3TNE78 metal 719818-92625
	Y-3TNC78-2	head gasket/joint de culasse 3TNC78 F180
	Y-3TN80-2	head gasket/joint de culasse 3TN80 (285x162mm)
	Y-3TNB80U-2	head gasket/joint de culasse FX18 129155-01332 (ex TI-3T80NB-2)

	Y-3TN82-2	head gasket/joint de culasse F20, FX20 (3TN82) TW (129156-01333) 3JH2E
	Y-3TN82-3	set gaskets upper/pochette joints
	Y-3TN82-4	gasket set full/pochette joints 3TN82 (729188- 92602)
	Y-129150-11310G	valve cover seal/joint cache culbuteur F18-F24
	Y-119812-01330G	head gasket/joint de culasse 3TNC80 metal OEM 283x152
	Y-119812-01330	« « « « 3TN82
	Y-3TNA84-2	head gasket/joint de culasse 3TNA84 FX-24 TW (HGY2006E) 129157-01332
	Y-3TNA84-3	set gaskets upper/pochette joints 3TNA84 TW
	Y-3TNA84-4	gasket set full/pochette joints 3TN84 TW (HFY2006E)
	Y-3TNE84-2MT	head gasket/joint de culasse 3TNE84 HGY2006C 129002-01331
	Y-3TNE84-3MT	set gaskets upper/pochette joints 3TNE84 metal

	Y-3TNE84-4MT	3TNE84 (729211-92670)
	Y-3TNE88-2MT	head gasket/joint de culasse 3TNE88 metal HGY2006F 129001-01340
	Y-3TNE88-3MT	set gaskets upper/pochette joints 3TNE88 metal
	Y-3TNE88-4MT	gasket set full/pochette joints 3TNE88 metal HFY2006F729001-92660
	Y-4TNA78-2	head gasket/joint de culasse F26.F28, FX26, FX 28 FX 32 (4TNA78U) HGY2007D
	Y-4TN82-2	head gasket/joint de culasse 4TN82 HGY2007B
	Y-4TN82-3	set gaskets upper/pochette joints 4TN82 TW
	Y-4TN82-4	gasket set full/pochette joints (no valve seal, no crank seals) 4TNA82 TW 729488-92605
	Y-4TNE84-2	head gasket/joint de culasse 4TNE84 4406
	Y-4TNE84-3	Set gaskets upper/pochette joints 4TNE84
	Y-4TNE84-4	gasket set full/pochette joints 4TN84 TW HFY2484
	Y-4TNE84-2MT	head gasket/joint de culasse 4TNE84 metal 129408-01330
	Y-4TNE84-3MT	set gaskets upper/pochette joints.4TNE84 metal HHY2484A
	Y-4TNE84-4MT	full 4TN84 TW metal 729618-92600
	Y-4TNV86-2	head gasket/joint de culasse 4TNV86 TW (metal) (HGY2012B TK486) 129704-01304
	Y-4TNV86-4	gasket set full/pochette joints 4TNV86 TW (metal) HFY2012B

	Y-4TNE88-3	set gaskets upper/pochette joints. 4TNE88 metal HGY2012
	Y-4TNE88-4	gasket set full/pochette joints 729407-92660
	Y-4TNV88-2	head gasket/joint de culasse 4TNV88 (TK486)

	Y-4TNE94-2	head gasket/joint de culasse 4TNE94 4D94 Komatsu permanit
	Y-4TNE94-2MT	« « « 4TNE94 4D94 metal HGY2008
	Y-4TNE94-3MT	set gaskets upper/pochette joints 4TNE94 4D94 metal
	Y-4TNE94-4MT	gasket set full/pochette joints 4TNE94 4D94 metal

	Y-4TNV94-2MT	head gasket/joint de culasse 4TNV94
--	--------------	-------------------------------------

	Y-4TNV94-4MT	gasket set full/pochette joints 4TNV94 metal
--	--------------	--

	Y-4TNE98-2MT	head gasket/joint de culasse 4TNE98 metal
	Y-4TNE98-3MT	set gaskets upper/pochette joints 4TNE94 metal
	Y-4TNE98-4MT	gasket set full/pochette joints 4TNE94 metal

	Y-4TNV98-2MT	head gasket/joint de culasse 4TNV98 metal
--	--------------	---

	Y-129907-01331G	OEM Yanmar
--	-----------------	------------

	Y-4TNV98-4MT	gasket set full/pochette joints 4TNV98 metal head gasket
--	--------------	--

	Y-4D105-2	head gasket/joint de culasse 4D105
	Y-4D105-4	gasket set full/pochette joints 4TNE105 (113mm joint) (HFK8801E)

	Y-4TNE106-4	
--	-------------	--

	Y-4TNV106-2	head gasket/joint de culasse 4TNE106 HGY2009K
	Y-4TNV106-3	4TNE106 HHY2009K
	Y-4TNV106-4	full 4TNV106 HFY2009K

	Y-3TNE66-20	con rod bearing/cousinet bielle STD 3TNE66/68 37x16 719260-23610	
	Y-3TNE66-21	« « « 0103TNE66/8 37x16	
	Y-3TNE66-22	« « « 0203TNE66/8 37x16	
	Y-3TNA68-20	« « « STD 3TNA68/72 40x16 719620-23600	
	Y-3TNA68-21	« « « 010 3TNA68 TW 3TN72 40X16	
	Y-3TNA68-22	« « « 020 3TNA68 TW 3TN72 40X16	
	Y-3TNV70-20	con rod bearing set STD 3TNV70	
	Y-3TNV70-21	« « « 010 3TNV70	
	Y-3TNV70-22	« « « 020 3TNV70	
	Y-3TNV76-20	con rod bearing set STD 3TNV76	
	Y-3TNV76-21	« « « 010 3TNV76	
	Y-3TNV76-22	« « « 020 3TNV76	
	Y-3TNE82-20	« « « STD3TN75,3TNA78/82 3TNC80 43x18 719810-23600	
	Y-3TNE82-21	« « « 010 3TNA78,3TN82 43x18	
	Y-3TNE82-22	« « « 0203TNA78 3TN82 43x18	
	Y-3TN84-20	« « « STD 3/4TN84-88 48x20 719150-23600	
	Y-3TN84-21	« « « 010 3/4TN84-88 48x20	
	Y-129150-23611G	« « « 010 3/4TN84-88 48x20 OEM	
	Y-3TN84-22	« « « 020 3/4TN84-88 48x20	
	Y-4TNE94-20	« « « STD4TNE94/98 58x23 129900-23600set of 4 pairs	
	Y-4TNE94-21	« « « 0104TNE94/4TNE98 58x23set of 4 pairs	
	Y-4TNE94-22	« « « 0204TNE94/4TNE98 58x23set of 4 pairs	
	Y-3TN100-20	« « « 3TNE100 STD 119000-23300	
	Y-3TN100-21	« « « 3TNE100 0.25mm 119000-23300	
	Y-4TNV106-20	« « « STD4TNE106 65x26.9R898A set of 4 pairs	
	Y-4TNV106-21	« « « 010 TNE106 123900-23600 set of 4 pairs	
	Y-4TNV106-22	« « « 0204TNE106 65x26.9 set of 4 pairs	
		Y-3TNE66-25	main bearing/coussinetVilbrequin STD 3TNE66 40x16119620-02800
		Y-3TNE66-26	« « « 010 3TNE66 40x16
Y-3TNE66-27		« « « 020 3TNE66 40x16	
Y-3TNA68-25		« « « STD3TNA68 3TN72 44X16	
Y-3TNA68-26		« « « 010 3TNA68 3TN72 44X16	
Y-3TNA68-27		« « « 020 3TNA68 3TN72 44X16	
Y-3TNV70-25		set main bearingSTD 3TNV70	
Y-3TNV70-26		« « «	
Y-3TNV70-27		« « «	
Y-3TNV76-25		set main bearingSTD 3TNV76	
Y-3TNV76-26		« « «	
Y-3TNV76-27		« « «	
Y-3TNE82-25		main bearing STD 3TNE78/82 47x18 119810-02800	
Y-3TNE82-26		« « « 010 3TNE78/82 47x18	
Y-3TNE82-27		« « « 020 3TNE78/82 47x18	
Y-3TN84-25		« « « STD 3/4TN84/88 51x20	
Y-3TN84-26		« « « 010 3/4TN84/88 010 51x20	
Y-129150-02871G		« « « 010 3/4TN84/88 010 51x20 OEM	
Y-3TN84-27		« « « 020 3/4TN84/88 020 51x20	
Y-4TNE94-25		« « « STD 4TNE94-98 STD 66x23(129900-02800)set of 5 pairs	
Y-4TNE94-26		« « « 010 4TNE94/98 010 66x23set of 5 pairs	
Y-4TNE94-27		« « « 020 4TNE94/98 02066x23set of 5 pairs	
Y-3TN100-25		« « « STD 3TNE100	
Y-4TNV106-25		« « « STD 4TNE106 74x27set of 5 pairs	
Y-4TNV106-26		« « « 010 4TNE106 74x27set of 5 pairs	
Y-4TNV106-27		« « « 020 4TNE106 74x27set of 5 pairs	
Y-119280-02930G		thrust/calage 3TNE66-68 (2 for 1 engine)(ex 3TNE66-30)	



Y-119260-02930	« « «	3TNE66-68 (1 for 1 engine) aftersales
Y-719620-02930G	« « «	3TNA68-E72 (2 for 1 engine)
Y-3TN72-30	« « «	3TNA68-E72 after sales
Y-119810-02931G	« « «	3TN82 STD OEM(1 for 1 engine)
Y-3TN84-30	« « «	3TN84 STD 129150-02930 /68-69mm)
Y-129150-02931G	« « «	3TN84 STD 129150-02930 (2 for 1 engine)
Y-4TNE94-30	« « «	4TNE94 STD
Y-4TNV106-30	« « «	4TNE106 130730-4006A00



Y-3TNE68-17	valve in/soupape aspiration 3TNE68/3TNA66 27x5.5x77.2 ^o 30o
Y-3TNE68-18	valve ex/soupape echappement 3TNE68/ 3TNA66 23x5.5x76.7
Y-3TNV70-17	valve ex/soupape echap. 3TNV70
Y-3TNV70-18	valve in/soupape aspiration 3TNV70
Y-3TN72-17	valve in/soupape aspiration 3TN72 45o 29.6x7x87.2
Y-3TN72-18	valve ex/soupape echap. 3TN72 25x7x87.2 45o
Y-3TN72-37	Valve in/soupape aspiration 3TN72 TW 30 ^o
Y-3TN72-38	valve ex/soupape echappement 3TN72 TW 30o
Y-3TNC80-17	valve in/soupape aspiration 3TNC80 7X32X95
Y-3TNC80-18	valve ex/soupape echappement 3TNC80 7X27X95
Y-3TN82-17	valve in/soupape aspiration.3TN88 45o 35x8x109700240
Y-3TN82-18	valve ex/soupape echappement 3TN88 30x8x109
Y-3TN82-37	valve in/soupape aspiration 3TN82 35x8x109 30o
Y-3T84-17	« « « « « « 3T84 37x8x100 V7020100
Y-3T84-18	valve ex/soupape echappement3T84 31x8x100
Y-4TNE94-17	valve in/soupape aspiration 4D94 41x8x115
Y-4TNE94-18	valve ex/soupape echappement 4D94 35x8x115 4
Y-4TNV94-17	valve in/soupape aspiration 4TNV94 33x8x103
Y-4TNV94-18	valve ex/soupape echappement 4TNV94 28x7x103
Y-4TNE106-17	valve in/soupape aspiration 36.5X7X117.5 45o
Y-4TNV106-17	« « « « « « 4TNV106 36.5X7X117.5 30o16V
Y-4TNV106-18	valve ex/soupape echappement 4TNV106/4TNE106 31x7x117.5 45o 7126100 B-16V
Y-4TNV106-17A	valve in/soupape aspiration 44.5x9x126 30o
Y-4TNV106-18A	valve ex/soupape echappement 39x9x126 45o



Y-3TN68-35	valve guide 3TNE68 6x10.5x33
Y-3TN72-35	valve guide 3TN72 7x12x35
K-V1505-35	valve guide 3T75 7x11.05x40
Y-4TN84-35	valve guide 4TN84
Y-4TNV94-35	valve guide 4D94
Y-3TN100-35	valve guide 3TN100
Y-4TNV106-35	valve guide 4TNV106



Y-3TNE68-38	con rod bush/bague de bielle .3TN68 21x23x25 (119260-23910)
Y-3TN72-39	« « « «3TN72 119620-23910
Y-119620-23910G	« « « « 3TN72 119620-23910 OEM
Y-3TN84-38	« « « « 3TN84 26x29x27.5 729402-23100
Y-4TNV106-38	« « « « 4TNE106 123900-23910



Y-3TNE66-50	con rod assy/bielle 3D66 D43xD21xLinti 80mm 719620-3100
Y-729402-23100	con rod assy/biele 4TNE82-84-88 51x26x97mm
Y-4TNE94-50	con rod assy/bielle 4D94























Y-3TNE84-60	crankshaft/villebrequin 3TNE84, 3TNB84 (F22) (94mm)
Y-3TNV84-60	crankshaft/villebrequin 3TNV84 (97mm)





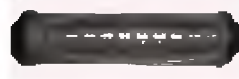

Y-3TNV84-60FG	crankshaft/villebrequin 3TNV84 (97mm) Forged (3x48/4x50/seal 38x85)
---------------	--

	Y-4TNE84-60	crankshaft/villebrequin 4TNE84 (95mm)
	Y-4TNV84-60	crankshaft/villebrequin 4TNV84 (97mm)
	Y-4TNE94-60	crankshaft/villebrequin 4TNE94 (113mm)
	Y-4TNV94-60	crankshaft/villebrequin 4TNV94 (118mm)
	Y-4TNV106-60	crankshaft/villebrequin 4SD106 Komatsu
	Y-4TNV84-60FG	crankshaft/villebrequin 4TNV84 (97mm) Forged (4x48/5x50/seal 38x85)
	Y-721-106-01	valve seal /joint de soupape. FX24-26, YM1900 YM2402, 8-13-10 HVS2012S Y-60-06-011
	Y-60-01-407	seal valve cover/joint cache culbuteur FX24
	Y-3TNA68-9	seal crank front/joint vbq frontal 3TNA68 30-44-7
	Y-60-06-372	* * * * 3/4TN84, 55-72-9 HTCR
	Y-4TNV106-9	* * * * 4TNV106 65x85x12
	Y-60-06-476	seal crank rear/joint vbq post HTCL 3TN84 85-102-12 BH1517E
	Y-124411-01780	* * * * 4TNV98 TA-TL 95-115-12 (ex 90-06-501)
	Y-4TNV106-8	* * * * 105x125x12
	Y-4TNV106-8A	ring supplementary 124,7x135x12
	Y-614-120-01	camshaft bush/bague arbre a cames EF352, EF463 45x48x22
	Y-129900-02410	* * * * 4TNE94-98 50x53x28
	Y-4TNE106-80	* * * * 4TNE106 58x61x33mm
	Y-BZ5486E	rear crankshaft seal/joint spy post / crank oil seal rear TK486 194120511 33-2974 85-105
	Y-129407-32000U (11499)	oil pump/pompe a huile Yanmar 3TNE82, 4TNE84-4TNE88 Thermoking TK486 H=63mm
	Y-158552-52100	oil pump/pompe a huile 4TNV94 HW
	129150-01200G	bolt head/vis culasse 3TNE82 10X1,5X97MM



	I-04-001	nozzles/nes d'injecteur F15-18, F22-26-28, FX32, YM1600-2000-2002-2202, YM2500, YM2610
	Y-60-04-005	* * * * DN-0SDYDI, 1300, 3T75, B1702, F20, FX20
	Y-DN-0SDYDI	DN0SDYDI F20, FX20, 3T75, B1702
	Y-DNOPD2	3TNA72
	Y-60-04-006	* * * * YM1601, 1702, 1802, 2001, 2202, YM2301 YM2402, YM2500 YMG1800
	Y-BDN0SD6827	* * * * SD6827 (ex Y-60-SD6827)
	Y-DNOPD62	* * * * PD62 thermoking

	Y-60-DSDY	« « « « 3T75
	Y-129102-53000	« « « « 4TNE84/4TNV86
	Y-11-46	« « « « Thermoking 11-46
	Y150P234H40	« « « « 4TNV86 thermoking
	Y-DN0PD2	« « « «
	121450-01951G	set shims diesel pumps 3T75U
	Y-194190-56900	RPM cable/cable compteur FX22, FX24 YM1500, 125cm (ex 60-07-001)
	Y-60-07-002	« « YM1700, YM2000/1(1.22m femxfem)
	Y-60-07-004	« « YM1301-1401, YM1510-1610
	Y-525-105-33	« « EF352
	Y-525-105-34	cable gear EF352
	Y-60-07-100	gauge oil/indicateur d;huile YM series
	Y-60-07-200	cable stop F14,15,16,17
	Y-194275-01500	« « « YM2310.2010 110 /78cm cover (ex 60-07-201)
	Y-194555-01510	« « « F18, FX20, Fx24 (ex 60-07-202)
	Y-615-205-03A	pump hydraulic/pompe hydraulique YM1300 4 holes, 64mm side cc shaft rectangle 13,5x8 H= 8mm rotation right 10lt/min
	K-615-205-01	pump hydraulic/pompe hydraulique F165 (L2402) 4 holes, 64mm side cc shaft rectangle shaft 12 dents (14mm) rotation left10lt/min
	Y-615-1027	pump hydraulic/pompe hydraulique EF352 left 12T (13mm) 13.5 lt/min
	Y-615-988	pump hydraulic/pompe hydraulique EF453 (9217979) 12T (13mm) left16lt/min
	Y-508-215-03	EF352T-EF494T 178070-10401
	Y-60-43024930	hydraulic finger filter/filter hydraulique F16, YM180,1602, 1720 L:200mm/25mm-16mm « « « . F17,18L:200mm 2 holes:25mm
	Y-60-51524930	
	Y-60-42310	« « « YM1500L:225mm Φ:40mm hole:28mm



	Y-60-42300	« « « YM1600-1900 L:215mm Ø:50mm T:55mm
	Y-512-208-15	hose hydraulic supply/durite hydraulique
	Y-608-203-02	filter hydraulic base/support filtre hydraulique EF352, AF33
	Y-60-48	filter hydraulic F15, F17, F20 11/8x16 Height 13cm seal 60mm int 194250-48310
	Y-501-123-24	« « « FX YM 39mm thread 75-79 rubber L=110
	Y-501-123-25	« « « EF453
	Y-60-SPH94008	« « « AF17, RS24, RS27 SFH2631



	Y-508-123-01	seal PTO/joint PDF EF352T AQ2110E 35-60/66- 13/19WLK available
	Y-508-100-01	seal front shaft/joint arbre frontal EF352T BQ6830E
	Y-508-101-15	« « « EF453TAE3746G 79-105-15
	Y-508-105-13	seal rear shaft/joint arbre arrier 72-100-16 EF352 BQ6878E
	TI-508-106-13	seal pinion/joint pignon EF352T 25-30-13 AE1748F
	Y-508-209-04	« « « 57-80-17/12 4TNV88 BQ4919E
	Y-508-209-06	« « « 3TNV88 BQ2386E 55-85-7/12
	Y-508-209-07	seal oil/joint EF352T 57-80/86-11/17 AE30721
	Y-508-206-03	seal front shaft/joint arbre frontal EF453T 35x41x5
	Y-521-111-22	seal shaft suspension/joint suspension EF352 lower 198200-62990
	Y-521-111-23	« « « EF352 upper 198200-62970
	Y-1E6210- 73230	« « « 25x47/54x13 TC6Y YM2200 YM2710
	Y-AQ3020P	« « « 54-80-10, TC
	Y-AE7451G	seal front wheel/joint roué ant 57-80-12 TC

	Y-AE7450F	joint 57-75-12 F14 front wheel TC
	Y-194306-13640G	Valve seat front knee 40x44x26 F205 F16 OEM Yanmar BQ2178E
	Y-194447-13650G	oil seal kee 44x57x11.5 F205 F16 OEM Yanmar BE1059E
	Y-194306-13630G	oil seal cover 48x57x10 F205 F16
	Y-194447-13640G	sleeve 40x44x15 F16 OEM
	Y-194447-14180G	52x57x18 AQ2967E F205 OEM Yanmar
	Y-194447-14140G	57x75x12 AE7450F F205 OEM Yanmar
	Y-BQ3163E	seal front wheel vertical 60-80-13/28 QLF cassette
	M-AQ7977P	« « « 60-82-17/19 (AQ3225F) 1W3990-30090 124450-02220 QLF Cassete
	Y-65-80-26	bush/bague 65x80x26
	Y-194171-13870	« « « vertical 68-90-12 TC
	Y-AG3613A	« « « 75-100-7 YM3000 TC
	Y-AE3618A	seal oil /joint 75-100-13 YM2500-3000 (24421- 750013/194145-32730) TC
	Y-BQ1393E	seal front wheel/joint roué avant 75-105-13 TC
	K-AQ8251P	seal oil/joint 115-135-12.5/24

	Y-45230	seal front differential /joint diffrentiel 4x4 (AE8172P) YM1300,YM1500 115x145x12
	Y-194311-13760	« « « YM1300 differential 4x4 115x145x13.5 AE8172P

	Y-60-05-401	filter tank/filter reservoir large
	Y-60-05-400	« « « small
	K-4-1515	oil filter/filter a huile YM2500, YM2610, YM2810, Ym3000, YM3220 , YM1301-1501, (1515) YM1702,1900, 2301, YM1600, 2000, F, FX C1605 124450-35100
	Y-60-37007	filter air/filter a airYM1300,130mm H=60mm 124060-12510
	Y-60-35	« « « Y1500 H= 80mm D 180mm Hole 120m124450-12510
	K-501-122-05	« « « F18, F20, F24 (ex Y-60-08-403) YM2010,YM2020,YM2310 (ex Y-60-08-403) JA- 804
	K-501-122-03	« « « YM1301, YM1401,YM1510,F15 (ex TI-60-08-409)
	K-50-1108F	« « « KE3 , KE415852-11080 185x130(cap)x(50int-80ext)
	Y-11-9300	air filter/filter air SB, SL-100 Thermoking
	Y-60-05-507	fuel filter/filter a go D35xH89 F24, YM220--1800- 2000-2301, YM2202-2620
	Y-60-05-508	« « « D50xH89x hole 20 F18-24, FX26-37, FX285, FX305 (45-507)
	I-37003	« « « L:67mm Φ:35mm Tp:12 YM1100,1300,1500,1700,2000,F16,F175
	Y-60-563014	« « « D30xH59K4A 5650-040-487-90
	K-4-43	« « « .51mmx36mmx12mm
	K-50-37011	bowl fuel filter/bouchon de filter YM(TI-4-617, 60- 05-502)
	Y-60-05-500	« « « YM1300-1610 44 extx68
	Y-124064-55510G	« « « YM1610 45/52x 78mm(104500- 55510) (respective 37003)
	K-501-204-03	« « « FFX74-60in (ex 60-05-503)

	Y-60-27002	fuel tank cap/bouchon reservoir 68mm x4mm pitch
	Y-517-113-12	« « « EF352T
	Y-517-113-11	« « « EF453
	Y-617-105-01	« « « EF453 198200-04030



	K-50-02-400	water pump bearing/ roulement pompe a eau YM1301, YM1401, YM1510, YM1610, YM1820, YM2202. YM2001, YM2310, YM1720 12x12x26
	K-523-105-01	« « « YM1600-1700-1900-2000-2210, YM2500-2600, FX24, FX26 12x16x30 885166K-3a
	Y-TK488	« « « TK486 12x35x16 total 126mm
	K-608-100-01	seal water pump/joint d;etainchete 28.5 YM1301, YM1401, YM1510, YM1610, YM1820, YM2202. YM2001, Ym2310, YM1720

	Y-3T72-40	water pump/pompe a eau F14, F15, YM1301-1401-1502-YM1410-1601-1602-1610-1702-1802-2001-YM2002-2010-2020-2220-2301-2310-2402-2420, YM180-186-220-250-276 Thermoking TK353 (0879K 06373) (124970-42100) 121450-42010
	Y-60-8001	water pump/pompe a eau YM2000(2TR20) YM330721250-42700 6 holes
	Y-60-8026	water pump/pompe a eau (YM2200?) 121023-42100 5 holes
	Y-119520-42000	water pump/pompe a eau 2TNE68 HW thermostat 44mm (TK374) 11-9496
	Y-119280-42000	water pump/pompe a eau 3TN66
	Y-3TN66-40	water pump/pompe a eau 3TN66 93mm
	Y-3TNA68-40A	water pump/pompe a eau 3TNA68 108mmFy
	Y-3TNA68-40	water pump/pompe a eau 3TNA68 & 3TNE72 TK388S, TK395, 3D72 119233-42000









	Y-3TNE68-40	water pump/pompe a eauKinki 3TNE68
	Y-119540-42000	water pump/pompe a eau2YINV70/3TNV70 HW
	Y-3TNE74-40	water pump/pompe a eau 3TNE74 119624-42001
	Y-A2300-40	water pump/pompe a eau A2300 (3TN82, FX24)
	Y-3D82-40	water pump/pompe a eau 3D82 (3TNE82)
	Y-3D84-40	water pump/pompe a eau 3D84 (ex 8027) 129327-42100
	Y-121000-42100	water pump/pompe a eau 3T75H YM1810
	Y-4TNE84-40	water pump/pompe a eau 4TNE84 3TNE88 129001-42004
	Y-4TNV88-40	water pump/pompe a eau 4TNV88 with tube
	Y-4TNE88-40	water pump/pompe a eau 4TNE88 129002-42004, 129001-42004, 729428-42007
	Y-4D94-40	water pump/pompe a eau 4D94 Komatsu
	Y-4D94LE-40	water pump/pompe a eau 4D94 Komatsu with tube (4TNV94)
	Y-4TNE92-40	water pump/pompe a eau 4TNE92 4TNE82 (FL140)

	Y-4TNE94-40	water pump/pompe a eau 4TNE94
	Y-4TNE98-40	water pump/pompe a eau 4TNE98 4TNA78 (4JH2E) (4JH4) (4JH3E) 129741-42001/129470-42001/129470-42033 FX24
		
	Y-4D106-40	water pump/pompe a eau 4TNE106 (4D106)
	Y-60-23-14	water pump/pompe a eau Thermoking TK486
	Y-13-2268	water pump/pompe a eau Thermoking TK486 HL
	Y-129350-49530G	thermostat base/couvercle calorstat FX18 OEM
	Y-129350-49800	thermostat/calorstat 44mm 71C TNE68/3TNA72
	Y-129350-49800G	thermostat/calorstat 44mm 71C 3T80 2TNE68/3TNA72 OEM
	Y-129155-49801G	thermostat/calorstat 3TNE80,3TNE82 4TNE84 71 Co OEM double 44mm
	Y-129155-49800	thermostat/calorstat 3TNE80,3TNE82 4TNE84 Φ44 71 Co double eccentric
	Y-607-135-03	« « « « Φ44 71 Co double eccentric (129155-49802)
	Y-124610-48620	thermostat/calorstat 82Co 4TNE106 (72mm double)
	Y-129335-44740	fan/ventilateur 3TNE88 HW
	Y-129900-44700	fan/ventilateur 4TNE94 HW





	Y-119600-52021	fuel pump/pompe a go
	Y-129301-52020	« « « « « 3TN66, 3T84 2GM20, 3GM30 (128270-52010, 121256-52021)
	Y-105582-52010	« « « « « 3GMD, 2QM, 2QM20Y
	Y-121256-52021	« « « « « 2GM20
	Y-124070-52040	« « « « « 2QM15
	Y-60-8914	fuel pump/pompe a go piston height 19mm
	Y-129100-52100	fuel pump/pompe 4TNV98T, 3TNV88, 4TNV98, 4TNV88T
	Y-119225-52102	fuel pump/pompe 4TNV98 (exTI-60-84)
	Y-129612-52100	fuel pump/pompe 3TN82 (exTI-60-53)
	Y-1733	Thermoking 482-486
	Y-AM132715	fuel pump/pompe John Deere Lawn 2243 LX172, LX279
	Y-44-9181	solenoid Thermoking 44-9181

	Y-41-6383	solenoid Thermoking 42-100, 41-4306, 41-9100, 71-6383
	Y-44-6727	solenoid M24x1mm Thermoking Cummins case N Holland TU-180 iseki, MT1801, Komatsu 6 cyl.





	Y-119653-77950	solenoid Yanmar 4TNE84 (John Deere)(5864004350)1503ES-12S5SUC5S (625-100-11) 4TNE88F7
	Y-119233-77932	solenoid Yanmar 2TNV70, 4TNV88, 3TNV88, 3TNE68, 4TNV94 1503ES-12S5SUC12S (MXL-1480A)
	K-052600-1001	solenoid 16271-60010/15471-60010 Denso Komatsu Kubota M5030
	Y-119629-66801	solenoid 3TNE88 (MXL1288-A)
	Y-10-01178-045V	solenoid Thermoking
	Y-129209-77950	solenoid 12271-77950 3YM30 2YM15 4LH4AE





	Y-124060-49020	hose radiator lower /durite radiateur inf YM1300 YM1500 28x28mm x26cm(ex TI-60-1500)
	Y-60-20-206	« « « « « « YM1300-1500
	Y-60-20-013	« « « « « infYM2000 124761-49020
	Y-60-20-010	hose radiator upper/durite radiateur sup YM2500, YM3000, YM3110., YM2610, 124768-49010, 121254-49010
	Y-60-20-202	hose radiator lower /durite radiateur inf YM1401, YM1502, YM1601, YM1702, YM1820, YM2001, YM2202, Ym2310 121450-49020
	Y-121450-49030	hose bypass YM1401, YM1502, YM1510 YM1601, YM1702, YM1820, YM2001, YM2202, Ym2310, F14, F15, F16 28x28mm x27cm (ex TI-60-1401)
	Y-60-20-002	hose radiator upper/durite radiateur sup F18, FX255, F22, F26, FX215, F20, FX22, FX24 -49010
	Y-60-20-209	hose radiator lower /durite radiateur inf F18, FX255, F22, F26, FX215, F20, FX22, FX24 121950-49020

	Y-60-36008	hose/durite L=240mm 25mmx4mm
	Y-60-36009	« « « L=215mm 27mmx4mm
	Y-512-203-17	hose radiator upper/ durite radiateur sup EF352
	Y-512-203-18	hose radiator lower / durite radiateur inf EF352
	Y-2068	radiator F14, F15
	Y-1462	radiator YM1301,1401, 1502, 1510 121551-44500
	Y-4160	radiator YM1100, YM1300, YM135, YM165124064-44500 & 124064-44500
	Y-4460	radiator YM1700, YM2000 Red YM240124460-44501
	Y-4768	radiator YM 2000, YM2210
	Y-9350	radiator YM2001, YM2202, YM2010, YM2220, YM2301, YM2402, YM2420 129350-44500
	Y-60-09-163	cap radiator45mm upper diameter
	Y-60-12-902A	thermosensor YM1700 124750-44902
	Y-121250-44901	« « « « « 3TNE68, 3TNE74

	Y-124250-49351	« « « « « 4TNV84, 4TNV88
	Y-114250-39450	oil switch 4TNV98
	Y-385720500	temp sensor
	K-50-09-100	radiator cap/bouchon de radiateur
	Y-60-12-800	bottle radiator/bouteille de radiateur YM 0.5Lt
	K-50-12-801	« « « « « FX

	K-625-100-10	switchoil(ex 525-109-05)
	Y-60-22-200	switch/commande de demareurD=32mm 3 contacts w/o pregeating
	Y-60-20-201	« « « D=55mm 6 contacts
	Y-60-20001	lamp YM1100,1300,1401,1502,1601,1810,2200
	Y-60-20005	« « YM1500,1700,2000,2001,2010, 2210,2310,2610,3000,3810,4000
	I-60-20003	« « F18, FX20-FX42

	Y-60-22-400	voltage regulator/regulateur de voltage YM1401, YM1501 121450-77710
	Y-60-22-401	« « « « 3 cables YM1500,1300,1110,135,155,165 OEM 124660-77710
	Y-124160-77710	voltage regulator/regulateur de voltage 3 cables YM11000,1300, YM155
	Y-60-12-951	voltage regulator/regulateur de voltage YM1501,
	Y-129150-77710	voltage regulator/regulateur de voltage F FX 18,20,22,24,26,28,32,37,49,215,225, 265,285 YM2610 5contacts OEM 129150-77710 (ex Y-60-22-404)

	Y-60-22-405	voltage regulator/regulateur de voltage YM1510, YM1601, YM1702, YM1810, YM2001, YM2301, YM2420 ,F13, F14, F15OEM 121522-77790/121450-77710/121450-77790 (YMF011101-6) 6 cables
	Y-60-12-950	voltage regulator/regulateur de voltage YM1600, YM1700, YM2000, YM2210, YM2500YM2610, YM3000, YM3310, YM38124550-77710
	Y-60-22-500	indicator/relaisindicateur YM1501, YM1510, YM1502, YM1520, YM1601, YM1610, YM1602, YM1620
	Y-121450-77710	voltage regulator/regulateur de voltage John Deere 650-750 (Same 60-22-405, B5100, B7100)
	Y-119853-77711	voltage regulator/regulateur de voltage 3TNE74 HW (119640-77710)
	Y-119000-77711	voltage regulator/regulateur de voltage AF28
	Y-119640-77710	voltage regulator/regulateur de voltage
	Y-RG009	4TNV94 landini

	K-Y103K	glowplug/ bougie de prechauffage 3TNE68 NGK (ex K-50-23-004)
	Y-Y-720U1	glowplug/bougie de prechauffage F, FX (10x1.25) 10.5V (ex TI-60-04-112) 129155-77801
	Y-60-04-110	glowplug/bougie de prechauffageYM2200 124250-11500
	Y-129927-77900	relais glow plug/relais bougie de prechauffage
	Y-17558-65991	relais glow plug/relais bougie de prechauffage MM431762 (15694-65992)
	Y-129901-77960	relais glow plug/relais bougie de prechauffage 897105 7900 119650-77902 KE-2-4
	Y-128300-77920	relais
	Y-119802-77200	« « « « « Sino Cmp 12VDC
	Y-933110-00100	switch

	Y-4-511	starter/demareurYM 11 124070-77010, 124060-77010 Hitachi S114-219
---	---------	---

	Y-18426	3TNA72, 3TNA68
	Y-044-004	starter/demareur 15T EF453 (ex 509-104-06)
	Y-119717-77010	starter/demareur 3TNV70, 3TNV76 (9 teeth)
	Y-124976-77011	starter/demareur YM1600, YM1700 124450-77010 (S114- 46)
	Y-119136-77011	starter/demareur 4TN78, 4TN82 (15 teeth) 124250-77012 (Hitachi S12-23)
	Y-044-021	starter/demareur 4TN78
	Y-044-024	starter/demareur F28
	Y-129429-77010	starter/demareur 4TNE84 (15 teeth)
	Y-044-001	starter/demareur 4TNE88
	Y-044-005	starter/demareur 15T
	Y-044-011	starter/demareur 4TNE94, 4TNV98

	Y-044-002	starter/demareur 4TNE94
	Y-044-020	starter/demareur 4TNE106
	Y-19708	starter/demareur 4TNV106 9T 3Kw 129940-77010
	Y-123900-77010	starter/demareur 4TNE106 9T 3Kw
	Y-45-1688	starter/demareur Thermoking 482, 486 (9teeth)
	Y-45-2177	starter/demareur Thermoking 482, 486 (9 teeth)
	Y-S13-407	starter/demareur Thermoking 482, 486 (9 teeth) 2.2Kw
	Y-044-003	starter/demareur 4TNE94
	Y-609-101-02 (ex 509-105-04)	alternator EF352T
	Y-119836-77200	alternator 3TNE68/3TNE70

	Y-41-6780	alternatorThermoking
	Y-121450-77200	alternator YM1502, YM1810
	Y-129150-77202	alternator F17, F22, F24
	Y-124680-77990	Alternator YM1500
	Y-124756-77200	Alternator 2TR17, 2TR20
	Y-12112	Alternator 4TNE84, 3TNE84
	Y-12356	Alternator 3TNV78
	Y-12761	Alternator 4TNE106
	Y-119836-77200	Alternator
	Y-30-243	X426, X430

	Y-60-30004	key/cle YM1100
	Y-60-30006	key/cle YM F15
	Y-121250-44901	thermosensor3TNE68-2, 3TNE74, 3TNV70, 3TNE84
	Y124160-39450	oil switch 3TNE68, 3TNE74, 3TNV70, 3TNE84
	Y-623-133-15 (ex 523-101-33)	tie rod end/rotule RH EF352T thread 17x1.5 cone 14-16
	Y-623-133-14 (ex 523-101-34)	« « « « « « « « LH EF352T thread 17x1.5 cone 14-16
	Y-623-135-03 (ex 523-113-01)	« « « « « « « « EF453 Thread 16x1.5 cone 17-19

	Y-623-135-01 (ex 523-113-02)	« « « « « « « EF453 cone 17-19
	Y-623-101-66	tie rod end/rotule LH EF352 17-19 16x1.5
	Y-623-101-65	tie rod end/rotule RH EF352 17-19 16x1.5
	Y-608-120-17	stabilizer horizontal EF352 33-40cm
	PA-7010	bracket top link/support tirante 3eme YANMAR
	Y-60-26002	hauling bracket and support 3 point kit YM1301,1401 F14, F16
	Y-F165-50A	« « « « « F165
	Y-F165-50	« « « « « F165

	Y-60-33004	clutch cover/mecanisme YM 1300 YM 1401 YM155, 183mm (ex 502) 794200-21700
	Y-60-4176	disc clutch/disque embrayage 180mm 19T
	Y-60-32004	« « « « 180mm 19T (21mm) YM1401
	Y-60-5537-2	« « « « 180mm 10T (20mm) KE3-4. MT160 friction thickness 7,7mm
	Y-80-TK33-1U3	bearing clutch/butee 33x60.5x15 YM1401
	Y-60-33003	clutch cover/mecanisme YM F14/15 180mm
	Y-60-32003	disc clutch/disque embrayage F14 180mm 10T
	K-50-33005	clutch cover/mecanismeYM 1500. YM1600. Ym1700, YM2000 YM240, YM276 200mm

	Y-60-4175	disc clutch/disque embrayage 200mm 20T YM240, YM276, YM1810 YM2000
	I-90-4471	disc clutch/disque embrayage, F20, F22, F24 200mm 13T
	I-726-110-03	clutch cover/mecanisme 81/2' (216mm) FX28 YM2610 MT24, MT28
	Y-605-100-05	disc clutch/disque embrayage AF30 EF352T 9' (225mm) 13T
	Y-626-102-06	clutch cover/mecanisme EF352T 9' 225mmTA225, D32
	Y-605-100-06	disc clutch/disque embrayage EF453T D260mmx26T (28mm) H25mm
	Y-626-102-05	disc clutch/disque embrayage 260mm 15T EF453T
	Y-TK33-1U3	bearing clutch/butee YM1300
	Y-RCT3558	« « « « «KE2, KE3, KE4
	M-RCT4064S	« « « « « FX24 YM276 40x64
	K-623-114-01	« « « « « EF453 45x74x17mm
	Y-515-247-41	clutch pusher EF453T
	Y-502-117-10	bush/manchon 4x4 EF453T

	Y-270-312	wheel/roue 3x12 (10x34) 80mm 4 holes intercenter 130mm YM1800, YM1802, YM 2000, YM2002 F16, F17, F18, F20
	Y-270-412	« « « « « 4x12 (12.5x34) 80mm holes 4 kk.intercenter120mm 155D, 1300 1401 ref 194210-12850
	Y-270-414	« « « « « 4x14 (12.5x39) 80mm holes 4 intercenter130mm 195D, 1601D, 1700D, F16D
	Y-501-201-03	« « « « « 16' 6 holes 90mm central hole 150mm intercenter diagonal distance
	Y-612-100-04	disc brake/disquefrein EF453T 12T(43mm) 225mm
	Y-616-100-03	disc intermediary EF453T 160x236
	Y-612-100-03	disc brake/disque frein EF352TD=115mm 16T(30mm)
	Y-616-100-02	disc intermediary EF352T D=70x118 L=132mm GL340
	Y-60-29003	joint/accouplement YM/F14, KE3, KE4 14T x (17,5mm) L=110mm
	Y194516-13390	yoke/fourchette cross 20x55 15 teeth D=17mm F14, F16

	Y-60-28002	Masco/Masque YM1301,1401 F14, F16 194360-61250
	Y-60-24022	Sticker/Autocollant YM
	Y-F14-05	steering worm/arbre de direction KE4, F14, F16 F175, YM1401, YM1510
	Y-194193-31390	crown pinion/courrone pinion F16 Crown 43T(152mm) x pignon 194193-31390 7T(34,5mm)x18T(20mm) L=292mm Y-504-104-04
	Y-504-104-05	crown pinion/courrone pinion F165 Crown 44T(160 ext x 112int) pignon 7Tx 16T(30mm)x13T(25mm)
	Y-519-104-14	crown pinion/courrone pinion F20 Crown 43T(185ext X116int) Pignon 9Tx 28T(30mm)x13T(25mm) 194555-31300
	Y-519-104-15	crown pinion/courrone pinion F235, F265, FX24 Crown 46T(185extX125int) Pignon 9Tx 28T(30mm)x13T(25mm) 198360-31510
	Y-519-104-01	crown pinion/courrone pinion EF453T 49T(235mm)x D-in 140mm x9T L265mm
	Y-60-42003	shaft/arbreYM L=236mm 13Tx15T
	Y-504-106-02	crown front wheel/courrone roué avant EF352 48T(190mm) x25T(45mm) xH53mm 198200-14120
	Y-518-122-06	hub front wheel/moyeu EF352 25T(45mm) 6 holes 150mm opposite holes intercenter
	Y-518-118-09	shaft/arbreLH Ef352
	Y-518-118-10	shaft/arbre RH EF352
	Y-515-237-29	16T (22mm) L45mm/sleeve/manchon
	Y-601-107-01	collar secure front wheel/ 51x6 (36540-43422 1480, M7030, M8950.M7950)
	Y-502-113-23	arm/bras EF352
	Y-502-113-24	arm/bras EF453 20T 198133-44410
	Y-515-237-29	mush/manchon 16T (23mm) length 45mm
	Y-519-133-05	14T (58mm) X12T (22mm) H34mm EF352198200-13100/ front drive gear

	Y-519-131-18	11T(54mm) x21T (22.50mm) EF 352T 198238-14280
	Y-519-127-24	25TD88.5mmEF352T198200-13100
	Y-504-106-03	44T(220mm) x 18T(50mm) H119mm EF453 Crown front wheel
	Y-504-106-04	51T (200mm) x36T (45mm) H58mm 1A8310- 14330 Crown front wheel
	Y-619-105-01	68T 77,25x/87mm EF453T 198121-25840
	Y-618-123-03	25T (45mm) EF352 198200- 14110CC=150mmdiagonally /Dex 180mm
	Y-618-123-07	25T (45mm) 181x111.25mm 35/45mm 198283-14310
	Y-618-123-04	EF453 18T 198401-14110
	Y-517-115-29	LX352 E393T 198200-14130, EF352, EF393 W=255mmH=76mmDin 58mm
	Y-519-108-37	10T Dext 48mmDin 16mmEF352 (198200- 31810)
	Y-519-108-51	EF352 4x4 14T (51.5mm) x12T(22mm) H=24mm 194300-31550.
	Y-519-127-15	EF453 36Tx8Tx6TDext 174mm Din 40mm H=57mm L155mm
	Y-502-113-24	EF453 20T (55mmL310mmpin 19x74mm (same 3C315-42300) (198133- 44410)hydraulic arm EF452

	Y-519-101-35	EF453T 1A7890-53270
	Y-519-100-29	220x170/lamprightEF453
	Y-519-100-28	220x170/lamprightEF453
	Y-519-101-40	EF393Treflectorright
	Y-519-101-41	EF393Treflectorleft
	Y-519-101-32	220x170/lamp left EF453 1A7780-53260
	Y-519-101-33	220x170/lamprightEF453
	Y-625-153-08	Bearing case front shaft Ef352T EF393T
	Y-525-124-12	gasket PTO/ joint PDF
	Y-515-119-22	gasket forward reverse/joint reverse
	Y-515-124-11	gasket/joint
	Y-518-105-02	18T EF453
	Y-515-112-28	gasket side differential/joint cote differntiel EF352
	Y-523-101-66	tie rod end/rotule LH EF352
	Y-523-101-65	tie rod end/rotule RH EF352
	Y-623-133-06	tie rod end/rotule LH EF352 cone 17-20mm thread 16x1.5
	Y-623-133-07	tie rod end/rotule RH EF352 cone 17-20mm thread 16x1.5
	Y-121462-13491	muffler/pot d;echapement YM1510 altered

Архангельск (8182)63-90-72
Астана (7172)727-132
Астрахань (8512)99-46-04
Барнаул (3852)73-04-60
Белгород (4722)40-23-64
Брянск (4832)59-03-52
Владивосток (423)249-28-31
Волгоград (844)278-03-48
Вологда (8172)26-41-59
Воронеж (473)204-51-73
Екатеринбург (343)384-55-89
Иваново (4932)77-34-06

Ижевск (3412)26-03-58
Иркутск (395)279-98-46
Казань (843)206-01-48
Калининград (4012)72-03-81
Калуга (4842)92-23-67
Кемерово (3842)65-04-62
Киров (8332)68-02-04
Краснодар (861)203-40-90
Красноярск (391)204-63-61
Курск (4712)77-13-04
Липецк (4742)52-20-81
Киргизия (996)312-96-26-47

Магнитогорск (3519)55-03-13
Москва (495)268-04-70
Мурманск (8152)59-64-93
Набережные Челны (8552)20-53-41
Нижегород (831)429-08-12
Новокузнецк (3843)20-46-81
Новосибирск (383)227-86-73
Омск (3812)21-46-40
Орел (4862)44-53-42
Оренбург (3532)37-68-04
Пенза (8412)22-31-16
Россия (495)268-04-70

Пермь (342)205-81-47
Ростов-на-Дону (863)308-18-15
Рязань (4912)46-61-64
Самара (846)206-03-16
Санкт-Петербург (812)309-46-40
Саратов (845)249-38-78
Севастополь (8692)22-31-93
Симферополь (3652)67-13-56
Смоленск (4812)29-41-54
Сочи (862)225-72-31
Ставрополь (8652)20-65-13
Казахстан (772)734-952-31

Сургут (3462)77-98-35
Тверь (4822)63-31-35
Томск (3822)98-41-53
Тула (4872)74-02-29
Тюмень (3452)66-21-18
Ульяновск (8422)24-23-59
Уфа (347)229-48-12
Хабаровск (4212)92-98-04
Челябинск (351)202-03-61
Череповец (8202)49-02-64
Ярославль (4852)69-52-93